

Article number: 12317000040160

Description: KLEE-coil 317 000 040.160
M4 Hardened/zinc-plated slotted pin

Measures

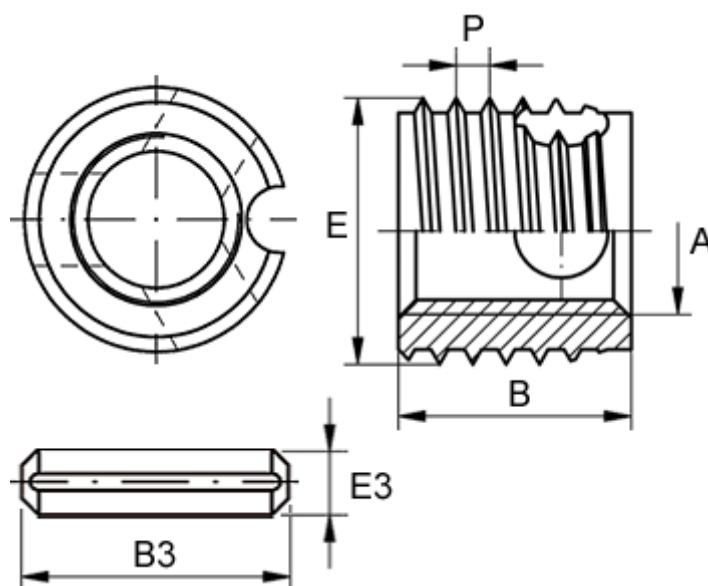

Female thread A	= M4
Length B	= 6
Male thread E	= 6.5
Min hole depth blind hole	= 8
Slotted pin B3	= 4
Slotted pin E3	= 2
Thread pitch P	= 0.80
Type	= 317 000 040 ...